

FAG

6004-C

Deep groove ball bearing

Schaeffler ID:
0951217570000

Deep groove ball bearing 60...-C, single row, Generation C, steel sheet metal cage

Technical information

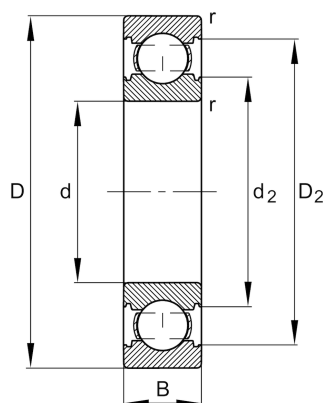
**Main Dimensions & Performance Data**

d	20 mm	Bore diameter
D	42 mm	Outside diameter
B	12 mm	Width
C_r	10.600 N	Basic dynamic load rating, radial
C_{0r}	5.000 N	Basic static load rating, radial
C_{ur}	340 N	Fatigue load limit, radial
n_G	27.500 1/min	Limiting speed
n_{gr}	19.700 1/min	Reference speed
	0,061 kg	Weight

Dimensions

r_{min}	0,6 mm	Minimum chamfer dimension
D_2	37,4 mm	Caliber diameter outer ring
d_2	25,2 mm	Caliber diameter inner ring

Mounting dimensions

$d_{a min}$	23,2 mm	Minimum diameter shaft shoulder
$D_{a max}$	38,8 mm	Maximum diameter of housing shoulder
$r_{a max}$	0,6 mm	Maximum fillet radius

Calculation factors

f_0	13,8	Calculation factor
-------	------	--------------------

Temperature range

T_{min}	-30 °C	Operating temperature min.
T_{max}	120 °C	Operating temperature max.

